

Data Sheet



Article number: 5861810808

Description: Flow Control Valve 181.0808, Ø8 Ø8
Push-in

Measures

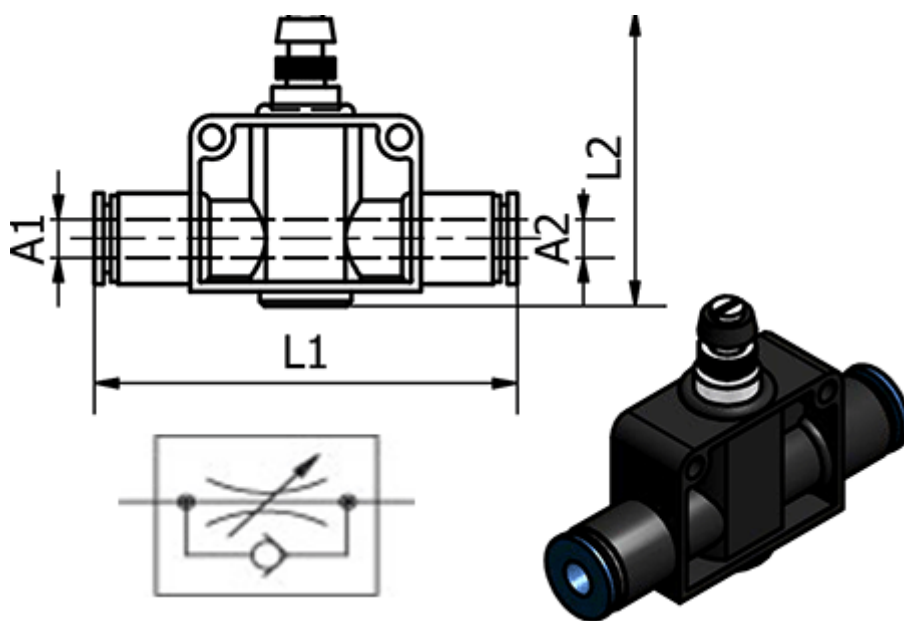

Ext. Hose Diameter A1 = 8

Ext. Hose Diameter A2 = 8

L1 = 51.8

L2 = 45.6